

# ROTATOR GR30

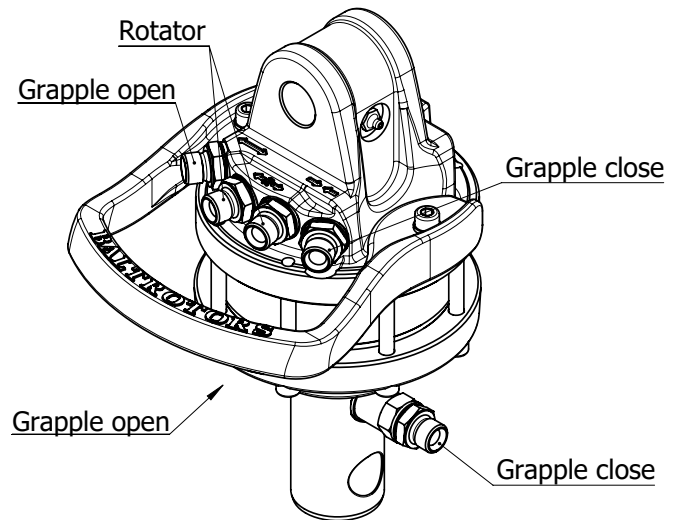
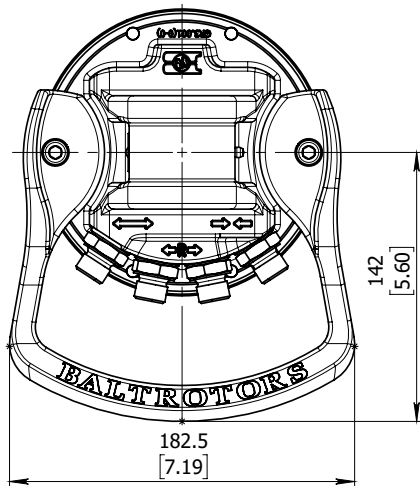
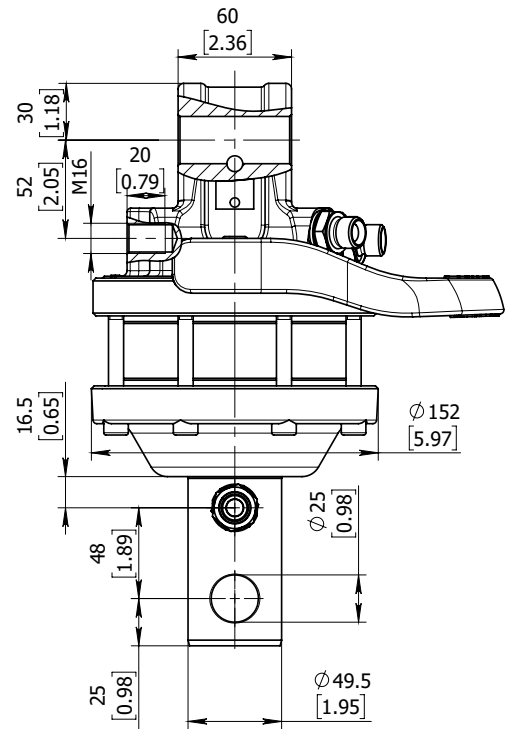
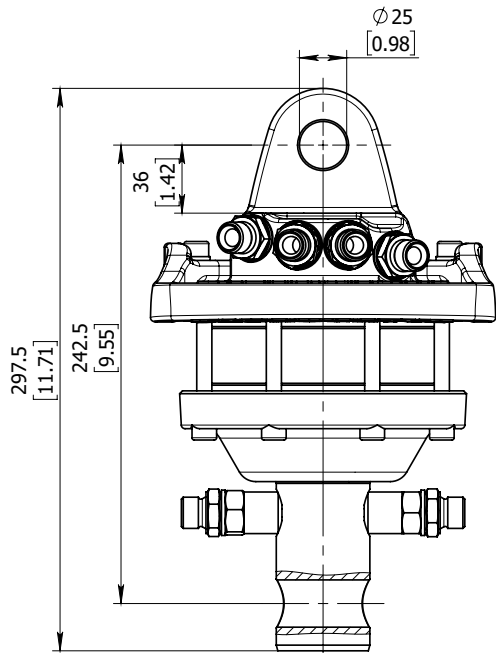

## Technical data

Rotation	Unlimited
Max axial load static, KN (lbf)	30 (6745)
Max axial load dynamic, KN (lbf)	15 (3372)
Torque at 25Mpa (3625psi), Nm (lb ft)	1000 (738)
Rec oilflow, l/min (US gallon)	20 (5.3)
Weight, kg (lb)	15 (33)

### Max working pressure:

Rotator	←R→	Max 25 MPa (3625 psi)	G 3/8
Grapple / Tool open	←G→	Max 20 MPa (2900 psi)	G 3/8
Grapple / Tool close	→G←	Max 30 MPa (4350 psi)	G 3/8

### Connection: