



Vickers

Screw-in Cartridge Valves

For Industrial and Mobile Applications



Screw-in Cartridge Valves (SiCVs)

Introduction

For over seventy years, the Vickers brand has provided its customers with quality products and innovative solutions for all their power and motion control needs. The products featured in this catalog represent the very best in screw-in cartridge valve technology. Eaton is committed to maintaining this position by offering the most comprehensive range of cartridge valves for stationary and on/off highway equipment. This catalog gives detailed specifications for the entire line of Vickers screw-in cartridge valves. Its purpose is to provide a quick, convenient reference tool when choosing cartridge valves or designing a system using these components. It is divided into sections according to valve function.

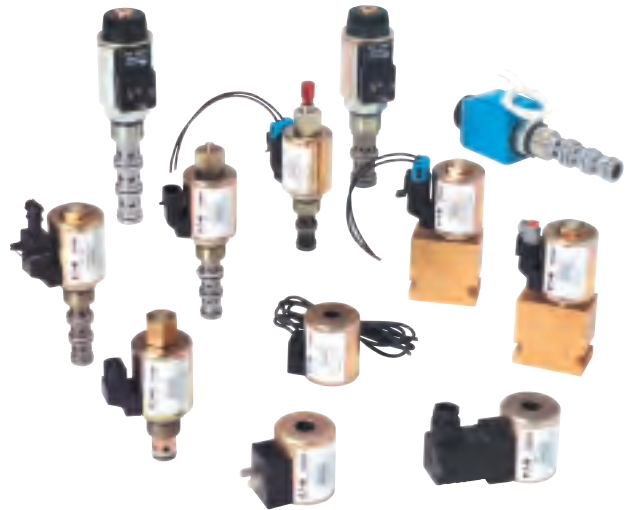

Features and Benefits

Vickers screw-in cartridge valves provide many advantages over traditional hydraulic valves. While offering the same control functions as traditional hydraulic valves, screw-in cartridge valves are compact, reliable, and economical.

The concept of combining multiple cartridge valves in a common manifold offers both the mobile and industrial user substantial cost-saving advantages that cannot be achieved with traditional valving. Here are some of the advantages of Eaton-Vickers cartridge valves:

- Response times and efficiency gains, by eliminating many of the hoses, tubes and fittings necessary in traditional installations
- Fewer potential leakage points than with conventional valves ensuring cleaner, safer application environments
- Compact and neat assemblies for economy of space and weight
- Increased ability to withstand vibration, giving optimum machine reliability and performance
- Multiple mounting configurations offers maximum design flexibility
- Greater contamination tolerance
- Faster cycle times
- Lower noise levels
- Faster on-sight servicing and troubleshooting
- Resistance to fluid contamination
- Hardened ground steel operating parts

Modular Circuit Designs

Modular Circuit Designs (MCDs) are valve packages containing combinations of screw-in cartridge valves in a manifold block. The package is dedicated to the hydraulic control of a particular application. MCDs can be as extensive as necessary to meet the most complex applications or as simple as two or three cartridges in a basic single manifold.

All MCD packages are designed and manufactured by Eaton to customer specifications. Manifolds can be designed to hold the requisite cartridges, pilot pistons, orifice discs, or any other components needed for individual applications and integrated with other Eaton components. Standard cavity tooling provides precision machining of standard cartridge cavities.

Global Support

Eaton's world-wide distribution and service network is quick, reliable, and responsive to the customer's needs. Our customers can rest assured that no matter where they're located, Eaton will be there with unrivaled products and technical expertise.

Technical Support

Quality products are only part of Eaton's commitment to our customers. We also provide advisory, planning and design services specifically geared to your application and backed by on-time delivery.

Modular Circuit Designs

High Performance in one compact, efficient package

Customized Solutions from a Single Source

Eaton is a major supplier of Modular Circuit Design (MCD) manifold block systems. Application and use of MCD packages has spread across virtually every market and is a major growth area increasing at a rate 2 to 3 times the growth rate for the rest of the hydraulics industry.

Market trend forces are fueling growth away from line mounted valves to

subplate mounted valves to, ultimately, MCD Manifold Valve Systems. Operating costs - reduced complexity, elimination of leakage, and improved serviceability - as well as initial installed cost factors - compact size, lower purchase cost, reduced customer engineering, fewer component parts and a higher level of integration - are contributing to this trend.

No Leaks, No Lines

Vickers MCD packages are created to meet specific circuit or installation requirements where two or more valves are required. The valves are packaged by hydraulic product suppliers, or OEMs, into either aluminum or steel blocks instead of using traditional cast iron individual in-line valve bodies. This permits the creation of compact, leak-free valve control system packages while eliminating the cost and time to connect the valves together with lines and fittings. This capability satisfies many application requirements where available space for hydraulic components is limited. MCD packages are ideally suited for a quick and easy, low cost hydraulic circuit which has repetitive applications. This requirement actually led to the development of the screw-in cartridge valve (SiCV) concept.

From Screw-in Cartridge Valves to Complete Systems

SiCVs gained their initial market success and position in the agricultural equipment industry in the late 1960s. SiCV technology rapidly spread from the traditional basic valve control functions of flow pressure and direction to many specialty valve control functions that were not always practical or economical in the traditional cast iron housing configuration. From these modest but demanding beginnings in the agricultural vehicle and implement markets, the concept of packaging two or more valves to form a unique control system and/or subsystem quickly spread into other cost sensitive high volume markets. Examples include aerial work platforms, lift trucks, road pavers, road rollers, concrete pavers, small construct equipment vehicles, and mining equipment.

Market Trends

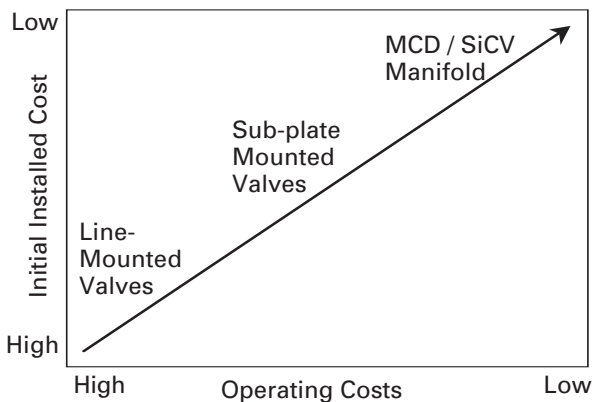

The Evolution of the MCD Package

This technology has evolved from labor intensive, costly line and subplate mounted components to compact leakfree MCD packages.

Line Mounted Valves



Mounted Sub-plate Mounted



MCD Package

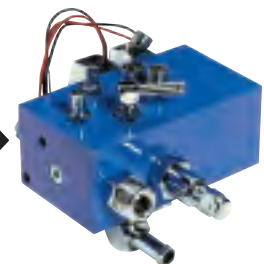

Modular Circuit Designs

High Performance in one compact, efficient package



Better Results in Many Applications

More industries are becoming aware of the advantages of MCD packages:

- Low installed cost
- Leak-free packaging
- Reduced hydraulic line clutter
- Smaller package size

As awareness increases, usage of MCD packages

is spreading to specialty vehicles and machines including paper cutting machines, newspaper printing presses, tree removal/planting vehicles, and utility trucks.

As more and more MCD packages continue to appear in the marketplace the use has spread to encompass virtually every conceivable market where hydraulic systems can be applied.



Trouble-free Installation and Troubleshooting

The MCD package may be designed by Eaton or customers to satisfy specific performance or installation requirements. The key design feature is the combination of two or more control functions into a compact manifold block where internal passages eliminate the need for interconnecting lines and fittings between valves. The construction eliminates not only potential leakage points, but also the procurement, storage, handling and installation costs associated with traditional line mounted valve systems. The only lines and fittings required are those for the system inlet and return and the connections to the actuators being controlled. In addition, the MCD is a complete package with no time or procurement problems to complete the installation of the circuit due to the possible shortage of one or more valves. Conveniently located SICVs in a single manifold block provide faster field servicing and troubleshooting, maximizing machine utilization.

Features and Benefits

- An efficient low maintenance system - the cartridge concept facilitates improved productivity from customized circuits
- Compact, unitized design - maximum savings on lines and fittings costs plus faster installation and system start up
- Fewer potential leakage points - ensure a cleaner, safer application environment
- Increase ability to withstand vibration - gives optimum machine reliability
- Faster response time and enhance efficiency - response time and power transmission efficiency gains by eliminating many of the hoses, tubes and fittings necessary in traditional installations
- Compact, neat assembly - provides space and weight savings
- Ability to manifold other valves such as Vickers Directional Controls DG valves & CMX valves - provides increased systems flexibility to control multiple and diverse actuators
- Components sourced from a single supplier - simplifies procurement processing and reduces acquisition costs

Aluminum and steel manifold packages with direct port STC connections

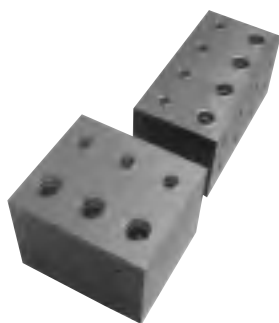

STC Ports in action

Design Features

- Positive round-wire style latching mechanism
- Swivels for installation, (in absence of pressure)
- Low profile, compact design
- Elastomeric o-ring seal –available in many materials
- Dual purpose dust seal/release sleeve
- Simple stamped release tool for disconnecting
- Zinc plated steel construction

Benefits

- Fast reliable one-hand STC connections requiring no assembly tools
- Easy installation in confined areas
- Eliminates cross-threading, over-or under-torquing, and hose twisting
- Resists loosening when vibration is present
- Zero leak performance per SAE J1176
- Repairable seals for increased useful life
- Direct porting eliminates adapters to maximize cost savings
- Resists external contamination
- Design allows easy disconnection with release tool
- Ease of assembly for MCDs with multiple ports in tight spaces

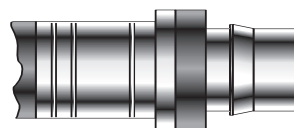

STC Hose/Connector

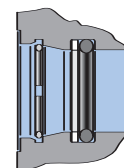

STC Port

How to Use STC STC Assembly Action

Note

Always remember to verify that your STC connection has been made successfully by pulling the connection.

The proper connection and disconnection of STC is outlined in Bulletin JA535E.



Male connector is inserted into the female connector. The male shoulder spreads the latch ring open.



Latch ring is in its open position which allows the male shoulder to slide past the latch ring.



Male and female are locked into place. As fluid pressure is applied, the latch ring is wedged between the male shoulder and the female angle.

As the STC tool is inserted behind the release sleeve, the steel insert pushes the latching ring forward into a groove in the female half I.D., thus allowing the two halves to be pulled apart. The thickness of the tool moves the sleeve forward far enough to disconnect, so prying sideways with the tool is unnecessary.



Screw-in Cartridge Valves

Contents

INTRODUCTION/VALVE LOCATORS - Section 0

Modular circuit designs (MCD)..... 0-3

Valve Locator

Solenoid valves..... 0-8
 Directional controls..... 0-12
 Proportional controls..... 0-14
 Pressure controls..... 0-16
 Flow controls..... 0-18
 Check valves..... 0-20
 Logic elements..... 0-22
 Load controls..... 0-23
 Circuit makers..... 0-23

SOLENOID VALVES - Section A

Section overview..... A-2
 2-way, 2-position, normally closed..... A-6
 2-way, 2-position, normally open..... A-50
 3-way, 2-position..... A-88
 4-way, 2-position..... A-106
 4-way, 3-position..... A-136
 Multi-functional Valves..... A-148
 Slip-in pilot 3-way 2-position..... A-150
 Manual override options..... A-152

PROPORTIONAL VALVES - Section B

Section overview..... B-2
 Proportional flow controls, poppet type..... B-4
 Proportional flow controls, spool type..... B-14
 Proportional pressure relief..... B-32
 Proportional pressure reducing/relieving..... B-40
 Slip-in pilot control valves..... B-48

COILS AND ELECTRONIC CONTROLS - Section C

Coils

S series, ToughCoil™..... C-5
 P series, ToughCoil™..... C-5
 J series, ToughCoil™..... C-6
 H series, ToughCoil™..... C-6
 R & L series coils..... C-10
 Explosion proof valve options..... C-11
 EPV proportional valve coils..... C-13
 EFV proportional valve coils..... C-14

Valve Drivers

Power plugs for proportional valves..... C-15
 "Soft switch" power plugs..... C-21

DIRECTIONAL CONTROLS - Section D

Section overview..... D-2
 Manual rotary valves, 3-way..... D-4
 Manual rotary valves, 4-way..... D-8
 Shuttle valves..... D-18
 Hot oil shuttle valves..... D-26
 Manual pull valves..... D-30
 Manual push valves..... D-34
 Pilot to shift valves, 3-way (single pilot)..... D-48
 Pilot to shift valves, 2-way (single pilot)..... D-76
 Pilot to shift valves, 3-way (dual pilot)..... D-78

PRESSURE CONTROLS - Section E

Section overview..... E-2

Relief Valves

Poppet type, 8 size..... E-4
 Differential area, 8 size..... E-6
 Ball Type, 10 size..... E-8
 Poppet type, 10 size..... E-10
 Differential area, 10 size..... E-14
 Pilot operated, 10 size..... E-18
 Thermal relief with check..... E-22
 Crossover relief..... E-24
 Pilot operated, 12 size..... E-26
 Differential area, 16 size..... E-28
 Pilot operated, 16 size..... E-30
 Pilot operated, ventable, 12 size..... E-32

Pressure Reducing/Relieving Valves

Direct acting..... E-34
 Pilot operated..... E-36

Pressure Sequence Valves

Direct Acting

External pilot, internal drain..... E-46
 Internal pilot, external drain, with vent..... E-54
 Internal or external pilot/drain..... E-58
 Internal pilot, external drain, without vent..... E-60
 External pilot, external drain, N/O..... E-62
 External pilot, external drain, N/C..... E-64

Pilot Operated

Internal pilot, external drain, 12 size..... E-66
 Internal pilot, external drain, with vent 16 size..... E-68

Special Functions

Pilot unloading..... E-70
 Accumulator discharge..... E-72

FLOW CONTROLS - Section F

Section overview..... F-2
 Flow regulator valves, fixed, pressure compensated.... F-4
 Flow regulator valves, adj., pressure compensated.... F-12
 Priority flow regulators (bypass type, fixed)..... F-22
 Priority flow regulators (bypass type, adjustable)..... F-28
 Static and dynamic signal priority valves..... F-32
 Manual rotary flow control cartridges..... F-38
 Needle valve cartridges..... F-42
 Flow control cartridges..... F-50
 Velocity fuse cartridges..... F-56
 Flow divider/combiner valves..... F-62
 Posi-traction valves..... F-72

CHECK VALVES - Section G

Section overview..... G-2
 Check valves, 2-way..... G-4
 Check valves, with bypass orifice..... G-20
 Restrictive check valves..... G-24
 Single PO check valves, cartridge..... G-26
 Single PO check valves, housing type..... G-30
 Single PO check valves, cartridge (high pressure)..... G-36
 Double pilot check valves, cartridge..... G-40
 Double pilot check valves, housing type..... G-42

LOAD CONTROLS - Section H

Section overview and application notes..... H-2
 Functional symbols..... H-5

Counterbalance valves	H-6
Vented counterbalance valves.....	H-10
Motion Control valves	H-14
Dual Motion Control valve.....	H-18
Dual Motion Control valve with Loadlock.....	H-20

LOGIC ELEMENTS - Section I

Section overview	I-2
------------------------	-----

Application Examples

Pressure control functions.....	I-4
Flow control functions.....	I-6
Directional control functions.....	I-9
Three-way bridge/four-way bridge.....	I-10
Differential pressure sensing valves.....	I-12
Spool type functional symbols	I-20
Poppet type functional symbols.....	I-21
Pressure compensators, restrictive type.....	I-22
Pressure compensators, bypass type	I-30

HOUSINGS AND MISC. PARTS - Section J

Section Overview	J-2
------------------------	-----

Standard Housings

C-**-2	J-3
C-**-3/3S	J-6
C-**-4.....	J-11
C-**-5S	J-14
Port dimensions	J-15

Special Housings

Part numbers - CBV, POC, VCB housings	J-15
Dimensions - 10 size CBV, POC housings	J-18
Dimensions - 12 size CBV, POC housings	J-21
Dimensions - 10 size VCB housings.....	J-25
Dimensions - 12 size VCB housings	J-27
Bolt on manifold for Eaton motors	J-29
Cavity plugs	J-36

Orifice Discs and Orifice Sizing

Orifice discs.....	J-40
Orifice sizing charts	J-41

Miscellaneous Parts

Pilot pistons	J-43
Sense check and panel mount adapter	J-44
Miscellaneous parts/adjustment kits	J-45

CIRCUIT MAKERS - Section K

Section overview.....	K-2
Flow control packages.....	K-4
Flow control package with free reverse flow	K-12
Pump control manifolds	K-20
Priority flow control with relief on priority flow port ...	K-28
Solenoid actuated relief valves.....	K-34
Cross port relief valves.....	K-44
Pressure sensitive regen. valve.....	K-48
Pressure sensitive regen. valve w/load locking.....	K-52
Cross port relief with shuttle and solenoid vent	K-56

SANDWICH VALVES - Section L

Application guidelines, ordering information	L-2
Spare parts & accessories	L-5
Valve locator	L-6
Model code detail for housings with two valves.....	L-20
Housing dimensions	L-25

TECHNICAL REFERENCE - Section M

General guidelines on manifold block design.....	M-3
Standard material sizes	M-5

Preferred tooling for machining custom manifolds.....	M-6
Torque specifications.....	M-8
Port dimensions - SAE & BSP.....	M-9
Port dimensions - short ports.....	M-10
Cavity.....	M-11
Machining recommendations.....	M-12
Cavity dimensions.....	M-13

INDEX BY MODEL CODE - Section N

VALVE LOCATOR

O

SOLENOID VALVES

A

PROPORTIONAL VALVES

B

COILS & ELECTRONIC CONTROLS

C

DIRECTIONAL CONTROLS

D

PRESSURE CONTROLS

E

FLOW CONTROLS

F

CHECK VALVES

G

LOAD CONTROLS

H

LOGIC ELEMENTS

I

HOUSING & MISCELLANEOUS PARTS

J

CIRCUIT MAKERS

K

SANDWICH VALVES

L

TECHNICAL REFERENCE

M

INDEX

N

Solenoid Valves

Valve locator

2-way, 2-position
normally closed

Functional Symbol

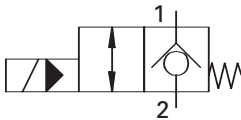
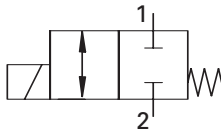
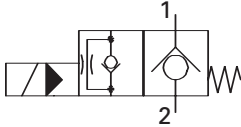

MODEL	CAVITY	FLOW RATING	TYPICAL PRESSURE	PAGE
Poppet type, pilot operated				
(restricted reverse flow when energized)		L/min (USgpm)	bar (psi)	
SV5-8-C/CM*	C-8-2	23 (6)	210 (3000)	A-6
SV15-8-C/CM*	C-8-2	37 (10)	350 (5000)	A-8
SV1-10-C/CM*/CR*†	C-10-2	45 (12)	210 (3000)	A-14
SV2-10-C/CM*/CR*†	C-10-2	23 (6)	210 (3000)	A-20
SV11-10-C/CM*	C-10-2	45 (12)	350 (5000)	A-16
SV12-10-C/CM*	C-10-2	23 (6)	350 (5000)	A-22

MODEL	CAVITY	FLOW RATING	TYPICAL PRESSURE	PAGE
Spool type, direct acting				
		L/min (USgpm)	bar (psi)	
SV4-8-C/CM*	C-8-2	11 (3)	210 (3000)	A-42
SV14-8-C/CM*	C-8-2	11 (3)	350 (5000)	A-44
SV4-10-C/CM*/CR*†	C-10-2	23 (6)	210 (3000)	A-46
SV14-10-C/CM*	C-10-2	23 (6)	350 (5000)	A-48

MODEL	CAVITY	FLOW RATING	TYPICAL PRESSURE	PAGE
Poppet type, pilot operated				
		L/min (USgpm)	bar (psi)	
SV3-10-C/CM*/CR*†	C-10-2	45 (12)	210 (3000)	A-24
SV13-10-C/CM*	C-10-2	45 (12)	350 (5000)	A-26
SV3-12-C/CM*/CR*	C-12-2 C-12-2-U	114 (30)	210 (3000)	A-28
SV13-12-C/CM*	C-12-2	114 (30)	350 (5000)	A-30
SV1-16-C/CM*/CR*†	C-16-2	132 (35)	210 (3000)	A-34
SV13-16-C/CM*	C-16-2	132 (35)	350 (5000)	A-36
SV2-20-C/CM*/CR*†	C-20-2	227 (60)	210 (3000)	A-38
SV13-20-C/CM*	C-20-2	227 (60)	350 (5000)	A-40

†Explosion proof, CSA Approved, coil option available (see page C-11)

*M = Manual override, *P = Push type manual override, *S = Screw type manual override, *R = Pull type manual override

Solenoid Valves (cont.)

Valve locator

Bi-directional, 2-way,
2-position normally closed

Functional Symbol

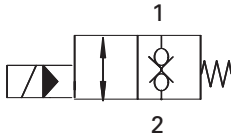

MODEL	CAVITY	FLOW RATING	TYPICAL PRESSURE	PAGE
Poppet type, direct acting		L/min (USgpm)	bar (psi)	
SBV12-8-C	C-8-2	1,0 (0,25)	350 (5000)	A-12
Poppet type, pilot operated				
SBV11-8-C	C-8-2	60 (15)	350 (5000)	A-10
SBV11-10-C	C-10-2	76 (20)	350 (5000)	A-18
SBV11-12-C	C-12-2 C-12-2U	114 (30)	350 (5000)	A-32

2-way, 2-position
normally open

Functional Symbol

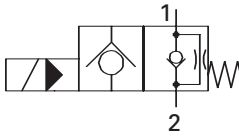

MODEL	CAVITY	FLOW RATING	TYPICAL PRESSURE	PAGE
Poppet type, pilot operated		L/min (USgpm)	bar (psi)	
SV5-8-0/OP*/OS*	C-8-2	23 (6)	210 (3000)	A-50
SV15-8-0/OP*/OS*	C-8-2	37 (10)	350 (5000)	A-52
SV5-10-0/OP*/OS*†	C-10-2	45 (12)	210 (3000)	A-60
SV15-10-0/OP*/OS*	C-10-2	45 (12)	350 (5000)	A-62

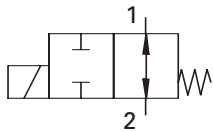

MODEL	CAVITY	FLOW RATING	TYPICAL PRESSURE	PAGE
Spool type, direct acting		L/min (USgpm)	bar (psi)	
SV4-8-0/OM*	C-8-2	13 (4)	210 (3000)	A-80
SV14-8-0/OM*	C-8-2	13 (4)	350 (5000)	A-82
SV4-10-0/OM*/OR*†	C-10-2	23 (6)	210 (3000)	A-84
SV14-10-0/OM*	C-10-2	23 (6)	350 (5000)	A-86

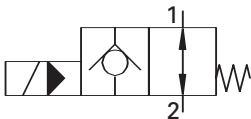

MODEL	CAVITY	FLOW RATING	TYPICAL PRESSURE	PAGE
Spool type, pilot operated		L/min (USgpm)	bar (psi)	
SV3-10-0/OP*/OS*†	C-10-2	45 (12)	210 (3000)	A-56
SV13-10-0/OP*/OS*	C-10-2	45 (12)	350 (5000)	A-58
SV3-12-0/OP*/OS*	C-12-2 C-12-2U	114 (30)	210 (3000)	A-66
SV13-12-0/OP*/OS*	C-12-2 C-12-2U	114 (30)	350 (5000)	A-68
SV3-16-0/OP*/OS*†	C-16-2	132 (35)	210 (3000)	A-72
SV13-16-0/OP*/OS*	C-16-2	132 (35)	350 (5000)	A-74
SV3-20-0/OP*/OS*†	C-20-2	227 (60)	210 (3000)	A-76
SV13-20-0/OP*/OS*	C-20-2	227 (60)	350 (5000)	A-78

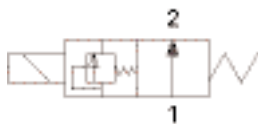

MODEL	CAVITY	FLOW RATING	TYPICAL PRESSURE	PAGE
Solenoid Operated Relief Valve		L/min (USgpm)	bar (psi)	
SRV4-12	C-12-2	114 (30)	250 (3600)	A-148

†Explosion proof, CSA Approved, coil option available (see page C-11)

*M = Manual override, *P = Push type manual override, *S = Screw type manual override, *R = Pull type manual override

Solenoid Valves (cont.)

Valve locator

Bi-directional, 2-way,
2-position normally open

Functional Symbol

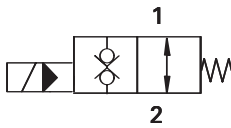

3-way, 2-position

Functional Symbol

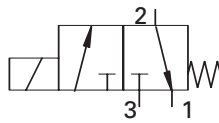
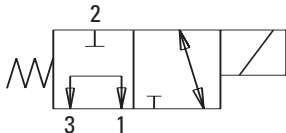
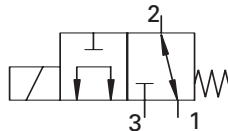

4-way, 2-position

Functional Symbol

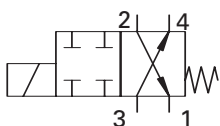
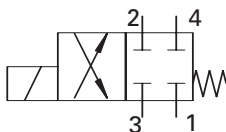
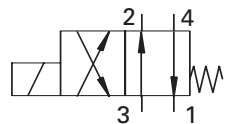

MODEL	CAVITY	FLOW RATING	TYPICAL PRESSURE	PAGE
Poppet type, pilot operated		L/min (USgpm)	bar (psi)	
SBV11-8-0	C-8-2	60 (15)	350 (5000)	A-54
SBV11-10-0	C-10-2	76 (20)	350 (5000)	A-64
SBV11-12-0	C-12-2	114 (30)	350 (5000)	A-70
	C-12-2U			

MODEL	CAVITY	FLOW RATING	TYPICAL PRESSURE	PAGE
Spool type, direct acting		L/min (USgpm)	bar (psi)	
SV1-8-3/3M*	C-8-3	11 (3)	210 (3000)	A-88
SV11-8-3/3M*	C-8-3	11 (3)	350 (5000)	A-90
SV1-10-3/3M*/3R*	C-10-3	23 (6) [‡]	210 (3000)	A-94
SV11-10-3/3M*	C-10-3	23 (6)	350 (3000)	A-96
SV1A/B-12-3P	C-12-3	42 (11)	210 (3000)	A-100

[‡]Flow port 1 to port 2 not to exceed 10 L/min (2.5 USgpm)

MODEL	CAVITY	FLOW RATING	TYPICAL PRESSURE	PAGE
Spool type, direct acting		L/min (USgpm)	bar (psi)	
SV2A/B-12-3P	C-12-3	38 (10)	210 (3000)	A-102

MODEL	CAVITY	FLOW RATING	TYPICAL PRESSURE	PAGE
Spool type		L/min (USgpm)	bar (psi)	
SV4-8-3/3M*	C-8-3	13 (4)	210 (3000)	A-92
SV4-10-3/3P*/3S*	C-10-3	23 (6)	210 (3000) [‡]	A-98
SV4A/B-12-3P	C-12-3	42 (11)	210 (3000)	A-104

[‡]Port 1 must be vented to tank. Tank pressure not to exceed 13,7 bar (200 psi)

MODEL	CAVITY	FLOW RATING	TYPICAL PRESSURE	PAGE
Spool type, direct acting, pilot operated		L/min (USgpm)	bar (psi)	
782 Series	38014_0	1,8 (0.5)	100 (1450)	A-150

MODEL	CAVITY	FLOW RATING	TYPICAL PRESSURE	PAGE
Spool type, direct acting		L/min (USgpm)	bar (psi)	
SV1-8-4/4M*	C-8-4	11 (3)	210 (3000)	A-106
SV11-8-4/4M*	C-8-4	11 (3)	350 (5000)	A-108
SV1-10-4/4M*/4R*†	C-10-4	23 (6)	210 (3000)	A-114
SV11-10-4/4M*	C-10-4	23 (6)	350 (5000)	A-116

MODEL	CAVITY	FLOW RATING	TYPICAL PRESSURE	PAGE
Spool type, direct acting		L/min (USgpm)	bar (psi)	
SV2-8-4/4M*	C-8-4	13 (4)	210 (3000)	A-110
SV12-8-4/4M*	C-8-4	13 (4)	350 (5000)	A-112
SV2-10-4/4M*/4R*†	C-10-4	23 (6)	210 (3000)	A-118
SV2A/B-12-4P	C-12-4	53 (14)	210 (3000)	A-128

MODEL	CAVITY	FLOW RATING	TYPICAL PRESSURE	PAGE
Spool type		L/min (USgpm)	bar (psi)	
SV3-10-4/4M*/4R*†	C-10-4	23 (6)	210 (3000)	A-120
SV3A/B-12-4P	C-12-4	53 (14)	210 (3000)	A-130

†Explosion proof, CSA Approved, coil option available (see page C-11)

*M = Manual override, *P = Push type manual override, *S = Screw type manual override, *R = Pull type manual override

Solenoid Valves (cont.)

Valve locator

4-way, 2-position

Functional Symbol

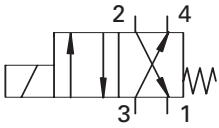
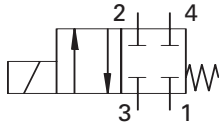
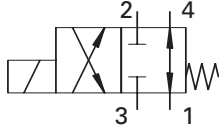

MODEL	CAVITY	FLOW RATING	TYPICAL PRESSURE	PAGE
Spool type, selector valve		L/min (USgpm)	bar (psi)	
SV4-10-4/4M*/4R*†	C-10-4	23 (6)	210 (3000)	A-122

MODEL	CAVITY	FLOW RATING	TYPICAL PRESSURE	PAGE
Spool type, selector valve		L/min (USgpm)	bar (psi)	
SV5-10-4/4M*/4R*	C-10-4	23 (6)	210 (3000)	A-124
SV5A/B-12-4P	C-12-4	53 (14)	210 (3000)	A-132

MODEL	CAVITY	FLOW RATING	TYPICAL PRESSURE	PAGE
Spool type		L/min (USgpm)	bar (psi)	
SV7-10-4/4P*/4S*	C-10-4	17 (5)	210 (3000)	A-126
SV7A/B-12-4P	C-12-4	46 (12)	210 (3000)	A-134

4-way, 3-position

Functional Symbol

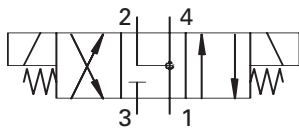
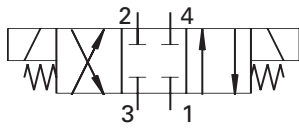
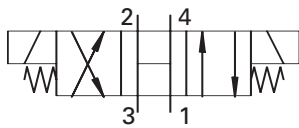
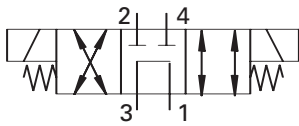

MODEL	CAVITY	FLOW RATING	TYPICAL PRESSURE	PAGE
Spool type		L/min (USgpm)	bar (psi)	
SV9-8-A/AM	C-8-4	13 (3.5)	210 (3000)	A-136
SV9-10-A/AM	C-10-4	19 (5)	210 (3000)	A-142

MODEL	CAVITY	FLOW RATING	TYPICAL PRESSURE	PAGE
Spool type		L/min (USgpm)	bar (psi)	
SV9-8-B/BM	C-8-4	13 (3.5)	210 (3000)	A-137
SV9-10-B/BM	C-10-4	23 (6)	210 (3000)	A-143

MODEL	CAVITY	FLOW RATING	TYPICAL PRESSURE	PAGE
Spool type		L/min (USgpm)	bar (psi)	
SV9-8-E/EM	C-8-4	13 (3.5)	210 (3000)	A-138
SV9-10-E/EM	C-10-4	23 (6)	210 (3000)	A-144

MODEL	CAVITY	FLOW RATING	TYPICAL PRESSURE	PAGE
Spool type		L/min (USgpm)	bar (psi)	
SV9-8-F/FM	C-8-4	13 (3.5)	210 (3000)	A-139
SV9-10-F/FM	C-10-4	23 (6)	210 (3000)	A-145

†Explosion proof, CSA Approved, coil option available (see page C-11)

*M = Manual override, *P = Push type manual override, *S = Screw type manual override, *R = Pull type manual override

Directional Controls

Valve locator

Manually operated

Functional Symbol

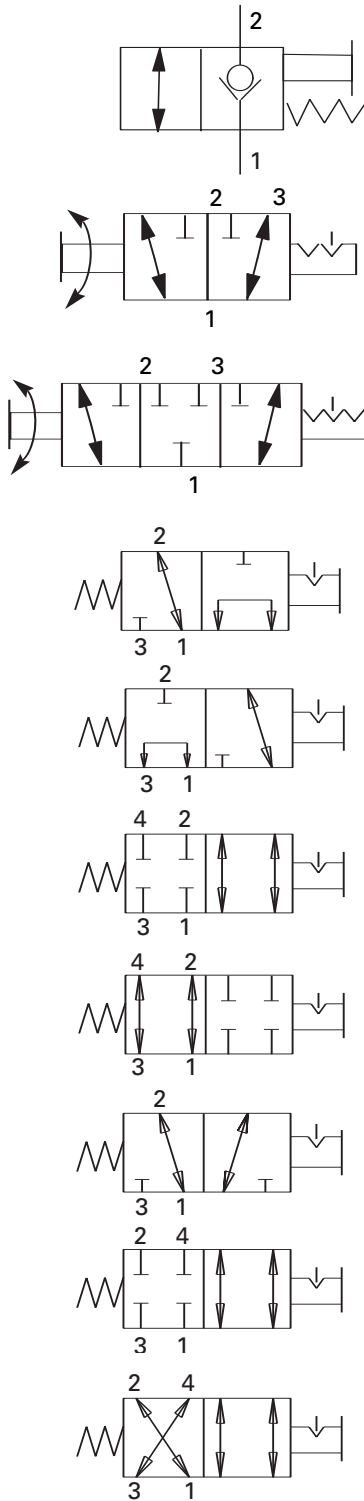

MODEL	CAVITY	FLOW RATING	TYPICAL PRESSURE	PAGE
Pull-to-open, 2-way, 2 position		L/min (USgpm)	bar (psi)	
MPV1-10	C-10-2	45 (12)	210 (3000)*	D-30
MPV3-10 (detent)	C-10-2	45 (12)	210 (3000)*	D-32

MODEL	CAVITY	FLOW RATING	TYPICAL PRESSURE	PAGE
Manual rotary, 2-position detent		L/min (USgpm)	bar (psi)	
MRV3-10-D2/E2	C-10-3	23 (6)	210 (3000)*	D-4
MRV3-16-D2	C-16-3	64 (17)	210 (3000)*	D-6

MODEL	CAVITY	FLOW RATING	TYPICAL PRESSURE	PAGE
Manual rotary, 3-position detent		L/min (USgpm)	bar (psi)	
MRV3-10-D/E	C-10-3	23 (6)	210 (3000)*	D-4
MRV3-16-D	C-16-3	64 (17)	210 (3000)*	D-6

MODEL	CAVITY	FLOW RATING	TYPICAL PRESSURE	PAGE
Push-to-open, 3-way, 2 position		L/min (USgpm)	bar (psi)	
MSV1-12	C-12-3	42 (11)	210 (3000)	D-34

MODEL	CAVITY	FLOW RATING	TYPICAL PRESSURE	PAGE
Push-to-open, 3-way, 2 position		L/min (USgpm)	bar (psi)	
MSV2-12	C-12-3	38 (10)	210 (3000)	D-36

MODEL	CAVITY	FLOW RATING	TYPICAL PRESSURE	PAGE
Push-to-open, 4-way, 2 position		L/min (USgpm)	bar (psi)	
MSV3-12	C-12-4	53 (14)	210 (3000)	D-40

MODEL	CAVITY	FLOW RATING	TYPICAL PRESSURE	PAGE
Push-to-open, 4-way, 2 position		L/min (USgpm)	bar (psi)	
MSV4-12	C-12-4	53 (14)	210 (3000)	D-42

MODEL	CAVITY	FLOW RATING	TYPICAL PRESSURE	PAGE
Push-to-open, 3-way, 2 position		L/min (USgpm)	bar (psi)	
MSV5-12	C-12-3	42 (11)	210 (3000)	D-38

MODEL	CAVITY	FLOW RATING	TYPICAL PRESSURE	PAGE
Push-to-open, 4-way, 2 position		L/min (USgpm)	bar (psi)	
MSV6-12	C-12-4	53 (14)	210 (3000)	D-44

MODEL	CAVITY	FLOW RATING	TYPICAL PRESSURE	PAGE
Push-to-open, 4-way, 2 position		L/min (USgpm)	bar (psi)	
MSV7-12	C-12-4	45 (12)	210 (3000)	D-46

Directional Controls (cont.)

Valve locator

Manually operated

Functional Symbol

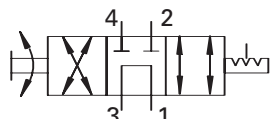
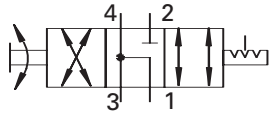
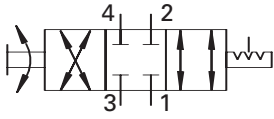

Pilot operated

Functional Symbol

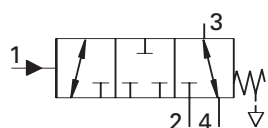
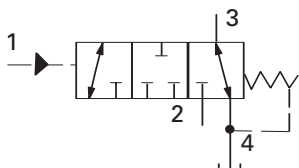
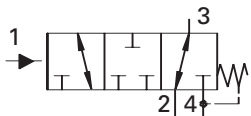
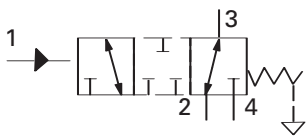
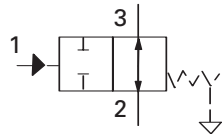
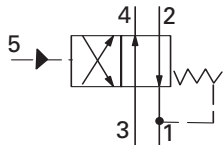

MODEL	CAVITY	FLOW RATING	TYPICAL PRESSURE	PAGE
Manual rotary, 4-way		L/min (USgpm)	bar (psi)	
MRV4-10-K	C-10-4	11 (3)	210 (3000)	D-8
MRV4-16-K	C-16-4	45 (12)	210 (3000)	D-10

MODEL	CAVITY	FLOW RATING	TYPICAL PRESSURE	PAGE
Manual rotary, 4-way, 3-position detented		L/min (USgpm)	bar (psi)	
MRV5-10-D/E	C-10-4	11 (3)	210 (3000)	D-12
MRV5-16-D	C-16-4	45 (12)	210 (3000)	D-14

MODEL	CAVITY	FLOW RATING	TYPICAL PRESSURE	PAGE
Manual rotary, 4-way, 3-position detented		L/min (USgpm)	bar (psi)	
MRV6-10-D/E	C-10-4	11 (3)	210 (3000)	D-16

MODEL	CAVITY	FLOW RATING	TYPICAL PRESSURE	PAGE
Manual rotary, 4-way, 3-position detented		L/min (USgpm)	bar (psi)	
MRV4-10-D/E	C-10-4	11 (3)	210 (3000)	D-8
MRV4-16-D	C-16-4	45 (12)	210 (3000)	D-10

* Indicates that these models are available for use above 210 bar (3000 psi). However, caution should be taken and a review of the application may be necessary prior to use. Contact your Eaton sales engineer.

MODEL	CAVITY	FLOW RATING	TYPICAL PRESSURE	PAGE
External pilot, internal drain, 4 way, 2 position		L/min (USgpm)	bar (psi)	
PTS6-10	C-10-4	23 (6)	210 (3000)	D-72

MODEL	CAVITY	FLOW RATING	TYPICAL PRESSURE	PAGE
External pilot, atmospheric vent, 2 way, 2 position		L/min (USgpm)	bar (psi)	
PTS7-10	C-10-3	30 (8)	210 (3000)	D-76

MODEL	CAVITY	FLOW RATING	TYPICAL PRESSURE	PAGE
External pilot, atmospheric vent, 3 way, 2 position		L/min (USgpm)	bar (psi)	
PTS1-10	C-10-4	30 (8)	210 (3000)	D-48
PTS1-16	C-16-4	132 (35)	210 (3000)	D-50
PTS1-20	C-20-4	265 (70)	210 (3000)	D-52

MODEL	CAVITY	FLOW RATING	TYPICAL PRESSURE	PAGE
External pilot, internal drain, 3 way, 2 position		L/min (USgpm)	bar (psi)	
PTS2-10	C-10-4	30 (8)	210 (3000)	D-54
PTS2-16	C-16-4	132 (35)	210 (3000)	D-56
PTS2-20	C-20-4	265 (70)	210 (3000)	D-58

MODEL	CAVITY	FLOW RATING	TYPICAL PRESSURE	PAGE
External pilot, internal drain, 3 way, 2 position		L/min (USgpm)	bar (psi)	
PTS3-10	C-10-4	30 (8)	210 (3000)	D-60
PTS3-16	C-16-4	132 (35)	210 (3000)	D-62
PTS3-20	C-20-4	265 (70)	210 (3000)	D-64

MODEL	CAVITY	FLOW RATING	TYPICAL PRESSURE	PAGE
External pilot, atmospheric vent, 3 way, 2 position		L/min (USgpm)	bar (psi)	
PTS4-16	C-16-4	132 (35)	210 (3000)	D-66

Directional Controls (cont.)

Valve locator

Pilot operated

Functional Symbol

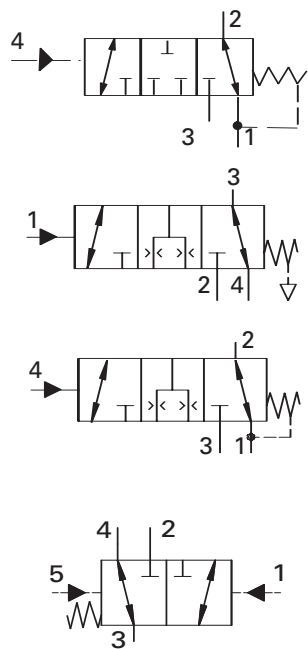

MODEL	CAVITY	FLOW RATING	TYPICAL PRESSURE	PAGE
External pilot, internal drain, 3 way, 2 position				
PTS5-10	C-10-3	11 (3)	210 (3000)	D-68

MODEL	CAVITY	FLOW RATING	TYPICAL PRESSURE	PAGE
External pilot, atmospheric vent, 3 way, 2 position				
PTS5-16	C-16-4	132 (35)	210 (3000)	D-70

MODEL	CAVITY	FLOW RATING	TYPICAL PRESSURE	PAGE
External pilot, internal drain, 3 way, 2 position				
PTS6-16	C-16-4	132 (35)	210 (3000)	D-74

MODEL	CAVITY	FLOW RATING	TYPICAL PRESSURE	PAGE
Dual External pilot, 3 way, 2 position				
PTS9-8	C-8-5S	19 (5)	280 (4000)	D-78
PTS9-10	C-10-5S	38 (10)	280 (4000)	D-80
PTS9-12	C-12-5S	76 (20)	280 (4000)	D-82
PTS9-16	C-16-5S	151 (40)	280 (4000)	D-84
PTS9-20	C-20-5S	228 (60)	280 (4000)	D-86

Manually operated

Functional Symbol

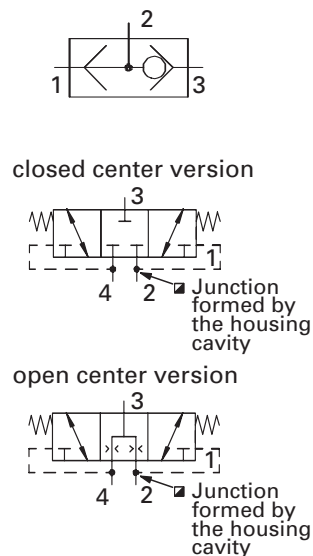

MODEL	CAVITY	FLOW RATING	TYPICAL PRESSURE	PAGE
Direct acting, ball type				
DSV2-4	C-4-3	3 (0.75)	240 (3500)	D-18
DSV2-8	C-8-3	23 (6)	240 (3500)	D-20
DSV1-10	C-10-3	23 (6)	210 (3000)	D-22
DSV3-6	None	11 (3)	350 (5000)	D-24
DSV3-8	None	25 (7)	350 (5000)	D-24
DSV3-12	None	90 (24)	350 (5000)	D-24
DSV3-16	None	170 (45)	350 (5000)	D-24

MODEL	CAVITY	FLOW RATING	TYPICAL PRESSURE	PAGE
Spring centered, hot oil shuttle valve with closed or open center				
DSV4-10-C/O	C-10-4	26 (7)	350 (5000)	D-26
DSV4-16-C/O	C-16-4	190 (50)	350 (5000)	D-28

Proportional Controls

Electrohydraulic pressure reducing/relieving

Functional Symbol

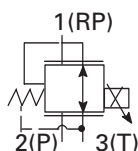

MODEL	CAVITY	FLOW RATING	TYPICAL PRESSURE	PAGE
Electrically operated, sliding spool type				
EPRV2-8	C-8-3	7,6 (2.0)	35 (500)	B-40

Proportional Controls

Valve locator

Electrohydraulic pressure reducing/relieving

Functional Symbol

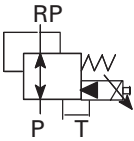

Electrohydraulic proportional relief

Functional Symbol

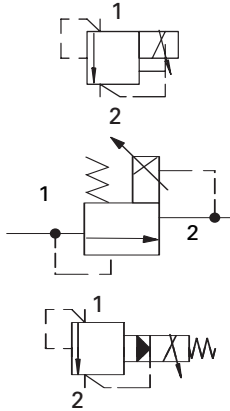

Electrohydraulic proportional flow regulator

Functional Symbol

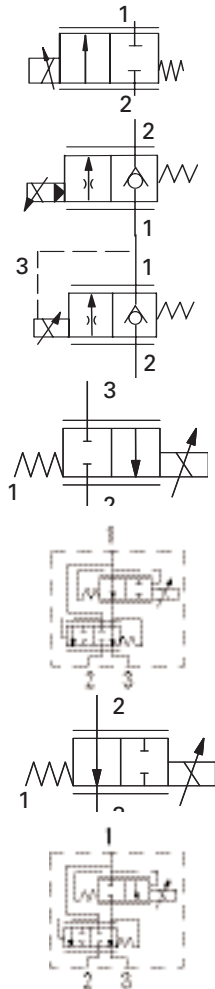

MODEL	CAVITY	FLOW RATING	TYPICAL PRESSURE	PAGE
Internal pilot, spool type				
EPRV1-10	C-10-3	8 (2)	35 (500)	B-42
EPRV3-10	C-10-3	30 (8)	210 (3000)	B-44
EPRV1-16	C-16-3	38 (10)	35 (500)	B-46

MODEL	CAVITY	FLOW RATING	TYPICAL PRESSURE	PAGE
Direct acting				
ERV2-10	C-10-2	3 (0.8)	210 (3000)	B-32

MODEL	CAVITY	FLOW RATING	TYPICAL PRESSURE	PAGE
2-stage, pilot operated				
ERV3-10	C-10-2	0,8 (0.20)	210 (3000)	B-34

MODEL	CAVITY	FLOW RATING	TYPICAL PRESSURE	PAGE
2-stage, pilot operated				
ERV1-10	C-10-2	4-57 (1-15)	210 (3000)	B-36
ERV1-16	C-16-2	8-132 (2-35)	210 (3000)	B-38

MODEL	CAVITY	FLOW RATING	TYPICAL PRESSURE	PAGE
2-way, proportional, normally closed				
EPV10	C-10-2	0-30 (0-8)	350 (5000)	B-4

MODEL	CAVITY	FLOW RATING	TYPICAL PRESSURE	PAGE
Nose in, side out				
EPV16-A	C-16-3S (modified)	0-160 (0-42)	280 (4000)	B-8

MODEL	CAVITY	FLOW RATING	TYPICAL PRESSURE	PAGE
Side in, nose out				
EPV16-B	C-16-3S (modified)	0-160 (0-42)	280 (4000)	B-8

MODEL	CAVITY	FLOW RATING	TYPICAL PRESSURE	PAGE
Direct acting				
EFV1-10*-C	C-10-3	38 (10)	210 (3000)	B-17
EFV1-12*-C	C-12-3	77 (20)	210 (3000)	B-23

MODEL	CAVITY	FLOW RATING	TYPICAL PRESSURE	PAGE
Direct acting				
EFV2-12*-C	C-12-3	114 (30)	210 (3000)	B-29

MODEL	CAVITY	FLOW RATING	TYPICAL PRESSURE	PAGE
Direct acting				
EFV1-10*-0	C-10-3	38 (10)	210 (3000)	B-14
EFV1-12*-0	C-12-3	104 (27.5)	210 (3000)	B-20

MODEL	CAVITY	FLOW RATING	TYPICAL PRESSURE	PAGE
Side in, nose out				
EFV2-12*-0	C-12-3	114 (30)	210 (3000)	B-26

Pressure Controls

Valve locator

Electrohydraulic proportional flow regulator

Pressure reducing/relieving

Functional Symbol

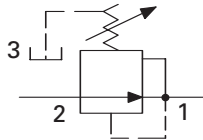
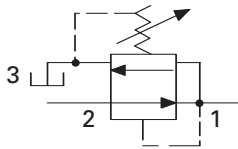

Pressure sequence valves

Functional Symbol

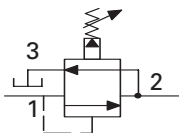
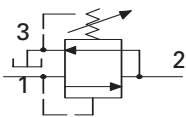
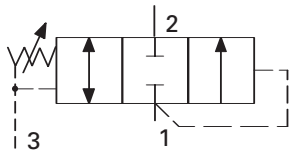
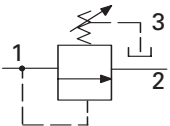
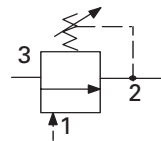
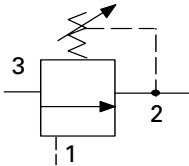

MODEL	CAVITY	FLOW RATING	TYPICAL PRESSURE	PAGE
Slip-in Pilot Control Valves		L/min (USgpm)	bar (psi)	
758 Series Flow Regulator		10 (2.6)	100 (1450)	B-48
758 Series Pressure Regulator		10 (2.6)	100 (1450)	B-50

MODEL	CAVITY	FLOW RATING	TYPICAL PRESSURE	PAGE
Direct acting, reducing & relieving		L/min (USgpm)	bar (psi)	
PRV1-10	C-10-3	15 (4)	165 (2400)	E-34
Pilot operated				
PRV2-10	C-10-3	38 (10)	240 (3500)	E-36
PRV12-10	C-10-3	45 (12)	350 (5000)	E-38
PRV12-12	C-12-3	114 (30)	350 (5000)	E-42
PRV2-16	C-16-3	151 (40)	350 (5000)	E-44

MODEL	CAVITY	FLOW RATING	TYPICAL PRESSURE	PAGE
Pilot operated, reducing only		L/min (USgpm)	bar (psi)	
PRV11-12	C-12-3	114 (30)	350 (5000)	E-40

MODEL	CAVITY	FLOW RATING	TYPICAL PRESSURE	PAGE
External pilot, sliding spool direct acting		L/min (USgpm)	bar (psi)	
PSV2-8	C-8-3	23 (6)	210 (3000)	E-46
PSV4-8	C-8-3	15 (4)	350 (5000)	E-48

MODEL	CAVITY	FLOW RATING	TYPICAL PRESSURE	PAGE
External pilot, internal drain, direct acting		L/min (USgpm)	bar (psi)	
PSV2-10	C-10-3	23 (6)	165 (2400)	E-50
PSV4-10	C-10-3	15 (4)	380 (5500)	E-52

MODEL	CAVITY	FLOW RATING	TYPICAL PRESSURE	PAGE
Internal pilot, external drain, direct acting		L/min (USgpm)	bar (psi)	
PSV7-10	C-10-3	23 (6)	125 (1800)	E-60

MODEL	CAVITY	FLOW RATING	TYPICAL PRESSURE	PAGE
Internal pilot, direct acting		L/min (USgpm)	bar (psi)	
PSV3-10	C-10-3	23 (6)	165 (2400)	E-58

MODEL	CAVITY	FLOW RATING	TYPICAL PRESSURE	PAGE
Internal pilot, direct acting		L/min (USgpm)	bar (psi)	
PSV1-10	C-10-3	23 (6)	165 (2400)	E-54
PSV5-10	C-10-3	8 (2)	380 (5500)	E-56

MODEL	CAVITY	FLOW RATING	TYPICAL PRESSURE	PAGE
Internal pilot, pilot operated		L/min (USgpm)	bar (psi)	
PSV1-16	C-16-3	95 (25)	415 (6000)	E-68

Pressure Controls (cont.)

Valve locator

Pressure sequence valves

Functional Symbol

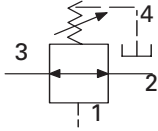

MODEL	CAVITY	FLOW RATING	TYPICAL PRESSURE	PAGE
External pilot, external drain, direct acting				
PSV8-10	C-10-4	23 (6)	165 (2400)	E-62

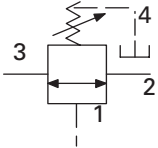

MODEL	CAVITY	FLOW RATING	TYPICAL PRESSURE	PAGE
External pilot, external drain, direct acting				
PSV10-10	C-10-4	23 (6)	165 (2400)	E-64

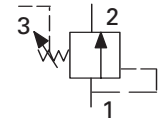

MODEL	CAVITY	FLOW RATING	TYPICAL PRESSURE	PAGE
Pilot operated, external pilot, spool-type, adjustable				
PSV11-12	C-12-3S	114 (30)	350 (5000)	E-66

Pressure unloading valve

Functional Symbol

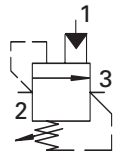

MODEL	CAVITY	FLOW RATING	TYPICAL PRESSURE	PAGE
Internal pilot, cartridge-type				
PUUV3-10	C-10-3	4 (1)	210 (3000)	E-70

Accumulator discharge valve

Functional Symbol

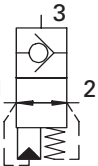

MODEL	CAVITY	FLOW RATING	TYPICAL PRESSURE	PAGE
External pilot to close (100:1 ratio)				
ADV1-16	C-16-3S	30 (8)	210 (3000)	E-72

Relief valves

Functional Symbol

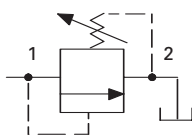

MODEL	CAVITY	FLOW RATING	TYPICAL PRESSURE	PAGE
Poppet, direct acting				
RV1-8	C-8-2	15 (4)	350 (5000)	E-4
RV1-10	C-10-2	30 (8)	210 (3000)	E-12
Low flow, ball type				
RV6-10	C-10-2	15 (4)	350 (5000)	E-8
Poppet, low pressure, direct acting				
RV10-10	C-10-2	38 (10)	70 (1000)	E-10

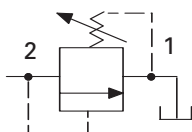

MODEL	CAVITY	FLOW RATING	TYPICAL PRESSURE	PAGE
Poppet, differential area				
RV8-8	C-8-2	30 (8)	350 (5000)	E-6
RV8-10	C-10-2	76 (20)	350 (5000)	E-16
RV3-10	C-10-2	76 (20)	250 (3600)	E-14
RV3-16	C-16-2	303 (80)	350 (5000)	E-28

Pressure Controls (cont.)

Valve locator

Relief valves

Functional Symbol

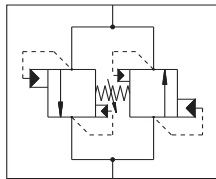
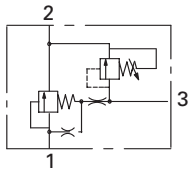
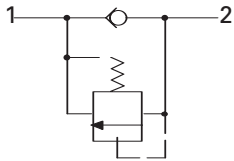
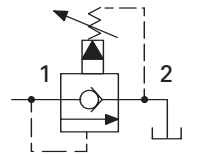
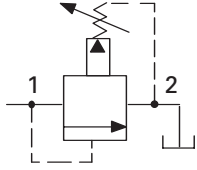

MODEL	CAVITY	FLOW RATING	TYPICAL PRESSURE	PAGE
Spool, pilot operated		L/min (USgpm)	bar (psi)	
RV5-10	C-10-2	114 (30)	350 (5000)	E-18
RV11-12	C-12-2 C-12-2U	190 (50)	350 (5000)	E-26
RV5-16	C-16-2	303 (80)	350 (5000)	E-30

MODEL	CAVITY	FLOW RATING	TYPICAL PRESSURE	PAGE
Poppet, pilot operated, free reverse flow		L/min (USgpm)	bar (psi)	
RV2-10	C-10-2	114 (30)	350 (5000)	E-20

MODEL	CAVITY	FLOW RATING	TYPICAL PRESSURE	PAGE
Poppet type, direct acting, thermal relief check valve		L/min (USgpm)	bar (psi)	
RV4-10	C-10-2	45 (12)	350 (5000)	E-22

MODEL	CAVITY	FLOW RATING	TYPICAL PRESSURE	PAGE
Vented spool, pilot operated		L/min (USgpm)	bar (psi)	
VRV11-12	C-12-3S	114 (30)	210 (3000)	E-32

MODEL	CAVITY	FLOW RATING	TYPICAL PRESSURE	PAGE
Cross over relief valve		L/min (USgpm)	bar (psi)	
CRV2-10	C-10-2	95 (20)	210 (3000)*	E-24

Flow Controls

Valve locator

Flow restrictors,
knob/lever operated

Functional Symbol

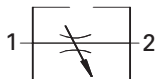

Flow restrictors,
adjustable

Functional Symbol

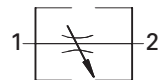

MODEL	CAVITY	FLOW RATING	TYPICAL PRESSURE	PAGE
Manual rotary		L/min (USgpm)	bar (psi)	
MRV2-10-K	C-10-2	60 (15)	210 (3000)	F-38
MRV2-10-B/E/D/L	C-10-2	60 (15)	210 (3000)	F-38
MRV2-16-K	C-16-2	170 (45)	210 (3000)	F-40
MRV2-16-B/E/D/L	C-16-2	170 (45)	210 (3000)	F-40

MODEL	CAVITY	FLOW RATING	TYPICAL PRESSURE	PAGE
Needle valve		L/min (USgpm)	bar (psi)	
NV1-8	C-8-2	45 (12)	350 (5000)	F-42
NV1-10	C-10-2	45 (12)	210 (3000)	F-44

Flow Controls (cont.)

Valve locator

Flow restrictors,
adjustable

Functional Symbol

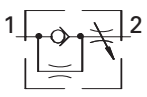

MODEL	CAVITY	FLOW RATING	TYPICAL PRESSURE	PAGE
Needle valve, restricted reverse flow		L/min (USgpm)	bar (psi)	
NV1-16	C-16-2	151 (40)	210 (3000)	F-46
NV1-20	C-20-2	265 (70)	210 (3000)	F-48

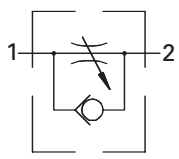

MODEL	CAVITY	FLOW RATING	TYPICAL PRESSURE	PAGE
Needle type with reverse flow check			L/min (USgpm)	bar (psi)
FCV7-10-FF	C-10-2	45 (12)	210 (3000)	F-50
Slotted spool with reverse flow check				
FCV7-10-(10)	C-10-2	6,6 (1.75)	210 (3000)	F-50
FCV7-10-(20)	C-10-2	14 (3.75)	210 (3000)	F-50
FCV7-10-(40)	C-10-2	27 (7.25)	210 (3000)	F-50

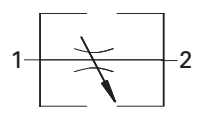

MODEL	CAVITY	FLOW RATING	TYPICAL PRESSURE	PAGE
Needle type		L/min (USgpm)	bar (psi)	
FCV7-10-(NV)	C-10-4	45 (12)	210 (3000)	F-50
FCV11-12	C-12-2 C-12-2U	114 (30)	350 (5000)	F-52
FCV6-16	C-16-2	208 (55)	210 (3000)	F-54
Needle type, fine adjustable				
FCV7-10-(NVF)	C-10-4	38 (10)	210 (3000)	F-50

Flow regulators

Functional Symbol

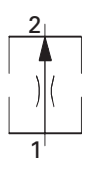

MODEL	CAVITY	FLOW RATING	TYPICAL PRESSURE	PAGE
(pressure compensated) Two way, pre-set flow		L/min (USgpm)	bar (psi)	
FR5-8	C-8-2	10 (2.5)	350 (5000)	F-4
FR5-10	C-10-2	23 (6)	350 (5000)	F-6
FR1-16	C-16-2	113 (30)	210 (3000)	F-8
FR1-20	C-20-2	227 (60)	210 (3000)	F-10



MODEL	CAVITY	FLOW RATING	TYPICAL PRESSURE	PAGE
(pressure compensated) Two-way, adjustable flow regulator		L/min (USgpm)	bar (psi)	
FR2-10	C-10-2	38 (10)	210 (3000)	F-12
FR2-16	C-16-2	113 (30)	210 (3000)	F-14

Flow regulators

Functional Symbol

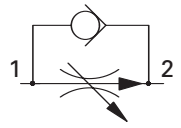

MODEL	CAVITY	FLOW RATING	TYPICAL PRESSURE	PAGE
Pressure compensated flow regulator		L/min (USgpm)	bar (psi)	
FAR1-10	C-10-2	1 - 38 (25 - 10)	350 (5000)	F-16
FAR1-12	C-12-2 C-12-2U	1,5 - 94,5 (0,44 - 25)	350 (5000)	F-18
FAR1-16	C-16-2	3,8 - 15,1 (1.0-4.0)	350 (5000)	F-20

Flow Controls (cont.)

Valve locator

Flow regulators

Functional Symbol

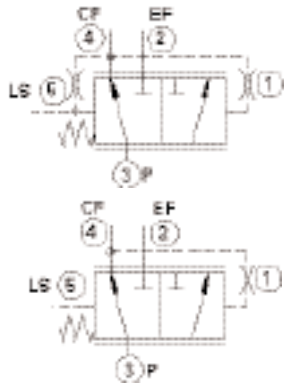
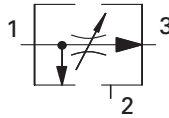
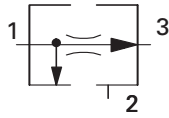

Flow dividers

Functional Symbol

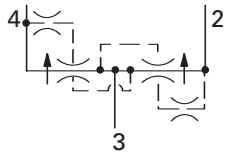
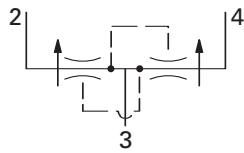

Velocity fuses
(pipe break valve)

Functional Symbol

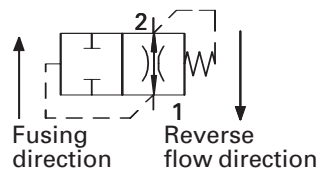

MODEL	CAVITY	MAX REG. FLOW L/min (USgpm)	MAX INLET FLOW bar (psi)	TYPICAL PRESSURE bar (psi)	PAGE
3-way priority flow regulator (fixed setting)					
PFR5-8	C-8-3	10 (2.5)	15 (4)	350 (5000)	F-22
PFR5-10	C-10-3	23 (6)	60 (15)	350 (5000)	F-24
PFR1-16	C-16-3	114 (30)	151 (40)	210 (3000)	F-26

MODEL	CAVITY	MAX REG. FLOW L/min (USgpm)	MAX INLET FLOW bar (psi)	TYPICAL PRESSURE bar (psi)	PAGE
3-way priority flow regulator 50% adjustable					
PFR2-10	C-10-3	38 (10)	60 (15)	210 (3000)	F-28
PFR2-16	C-16-3	114 (30)	151 (40)	210 (3000)	F-30

MODEL	CAVITY	FLOW RATING L/min (USgpm)	TYPICAL PRESSURE bar (psi)	PAGE
Dynamic Signal (PFRD)				
PFRD-12	C-12-5S	76 (20)	280 (4000)	F-32
PFRD-16	C-16-5S	150 (40)	280 (4000)	F-34
PFRD-20	C-20-5S	230 (60)	240 (3500)	F-36
Static Signal (PFRS)				
PFRS-12	C-12-5S	76 (20)	280 (4000)	F-32
PFRS-16	C-16-5S	150 (40)	280 (4000)	F-34
PFRS-20	C-20-5S	230 (60)	240 (3500)	F-36

MODEL	CAVITY	FLOW RATING L/min (USgpm)	TYPICAL PRESSURE bar (psi)	PAGE
Flow divider/combiner				
FDC1-10	C-10-4	68 (18)	210 (3000)	F-62
FDC11-10	C-10-4	9.5-38 (2.5-10)	350 (5000)	F-64
FDC1-16	C-16-4	178 (47)	210 (3000)	F-66
FDC11-16	C-16-4	84-152 (22-40)	350 (5000)	F-68
FDC1-20	manifold	378 (100)	210 (3000)	F-70
Posi-trachon valve				
FDC3-10	C-10-4	68 (18)	210 (3000)	F-72
FDC13-10	C-10-4	19-38 (5-10)	350 (5000)	F-74
FDC3-16	C-16-4	178 (47)	210 (3000)	F-76
FDC13-16	C-16-4	57-152 (15-40)	350 (5000)	F-78
FDC3-20	manifold	567 (150)	210 (3000)	F-80

MODEL	CAVITY	FLOW RATING L/min (USgpm)	TYPICAL PRESSURE bar (psi)	PAGE
Factory set				
VF11-10	C-10-2	23 (6)	210 (3000)	F-56
VF1-16	C-16-2	114 (30)	210 (3000)	F-58
VF1-20	C-20-2	227 (60)	210 (3000)	F-60

Check Valves

Valve locator

Direct operated

Functional Symbol



MODEL	CAVITY	FLOW RATING L/min (USgpm)	TYPICAL PRESSURE bar (psi)	PAGE
Direct acting, poppet type				
CV3-4	C-4-2	8 (2)	350 (5000)	G-4
CV3-8	C-8-2	30 (8)	350 (5000)	G-6
CV1-10	C-10-2	45 (12)	210 (3000)	G-8
CV11-10	C-10-2	45 (12)	350 (5000)	G-8
CV3-10	C-10-2	76 (20)	210 (3000)	G-10
CV13-10	C-10-2	76(20)	350 (5000)	G-10
CV11-12	C-12-2, C-12-2U	114 (30)	350 (5000)	G-14
CV1-16	C-16-2	151 (40)	210 (3000)	G-16
CV11-16	C-16-2	151 (40)	350 (3000)	G-16
CV2-20	C-20-2	227 (60)	210 (3000)	G-18

Check Valves (cont.)

Valve locator

Direct operated

Functional Symbol

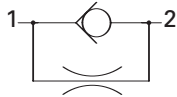

MODEL	CAVITY	FLOW RATING	TYPICAL PRESSURE	PAGE
Direct acting, poppet type		L/min (USgpm)	bar (psi)	
CV16-10	C-10-2	76 (20)	350 (5000)	G-12

MODEL	CAVITY	FLOW RATING	TYPICAL PRESSURE	PAGE
Direct acting, poppet type with orifice		L/min (USgpm)	bar (psi)	
CV6-10	C-10-2	76 (20)	350 (5000)	G-20
CV6-16	C-16-2	151 (40)	210 (3000)	G-22

MODEL	CAVITY	FLOW RATING	TYPICAL PRESSURE	PAGE
Direct acting, poppet type with stroke (flow) limiter		L/min (USgpm)	bar (psi)	
RCV3-10	C-10-2	76 (20)	350 (5000)	G-24

Pilot operated,
single acting

Functional Symbol

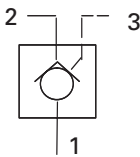
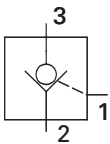

MODEL	CAVITY	FLOW RATING	TYPICAL PRESSURE	PAGE
Pilot-to-open		L/min (USgpm)	bar (psi)	
SPC2-8 (3:1 ratio)	C-8-3	19 (5)	240 (3500)	G-26
SPC2-10 (4:1 ratio)	C-10-3	23 (6)	210 (3000)	G-28
SPC1-10	manifold	45 (12)	210 (3000)	G-30
SPC1-16	manifold	151 (40)	210 (3000)	G-32
SPC1-20	manifold	227 (60)	210 (3000)	G-34

MODEL	CAVITY	FLOW RATING	TYPICAL PRESSURE	PAGE
Pilot-to-open (3:1 ratio)		L/min (USgpm)	bar (psi)	
POC1-10	C-10-3S	57 (15)	350 (5000)	G-36
POC1-12	C-12-3S	114 (30)	350 (5000)	G-38

Pilot operated,
double acting

Functional Symbol

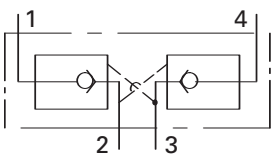
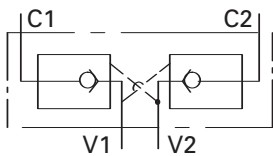

MODEL	CAVITY	FLOW RATING	TYPICAL PRESSURE	PAGE
Direct poppet 4:1 ratio manifold assembly		L/min (USgpm)	bar (psi)	
DPC1-10		45 (12)	210 (3000)	G-42
DPC11-12		114 (30)	350 (5000)	G-44
DPC1-16		151 (40)	210 (3000)	G-46
DPC1-20		227 (60)	210 (3000)	G-48

MODEL	CAVITY	FLOW RATING	TYPICAL PRESSURE	PAGE
Direct poppet 3:1 ratio, cartridge		L/min (USgpm)	bar (psi)	
DPC2-8	C-8-4	30 (8)	240 (3500)	G-40

Logic Elements

Valve locator

Differential pressure sensing

MODEL	CAVITY	FLOW RATING	TYPICAL PRESSURE	PAGE
Differential pressure sensing, spool type		L/min (USgpm)	bar (psi)	
DPS2-10	C-10-3S	57 (15)	240 (3500)*	I-12
DPS2-12**	C-12-3S	114 (30)	240 (3500)*	I-14
DPS2-16	C-16-3S	190 (50)	240 (3500)*	I-16
DPS2-20	C-20-3S	303 (80)	240 (3500)*	I-18

MODEL	CAVITY	FLOW RATING	TYPICAL PRESSURE	PAGE
Differential pressure sensing, poppet type		L/min (USgpm)	bar (psi)	
DPS2-10	C-10-3S	57 (15)	350 (5000)	I-12
DPS2-16	C-16-3S	190 (50)	350 (5000)	I-16
DPS2-20	C-20-3S	303 (80)	350 (5000)	I-18

* Indicates that these models are available for use above 240 bar (3500 psi). However, caution should be taken and a review of the application may be necessary prior to use. Contact your Eaton applications engineer.

** Only spool types available.

Functional Symbols

Spool type

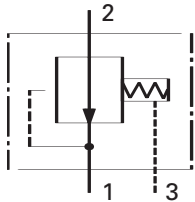

DPS2-**-F
Spool, flow control, normally open

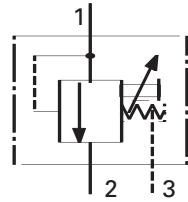

DPS2-**-P
Spool, normally closed

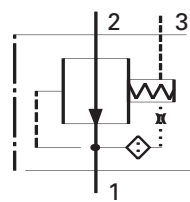

DPS2-**-R
Spool, pressure reducing, normally open

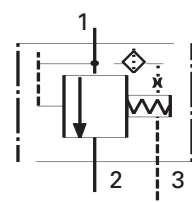

DPS2-**-V
Spool, normally closed

Poppet type

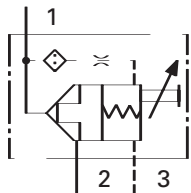

DPS2-**-B
Poppet, vent to open, normally closed

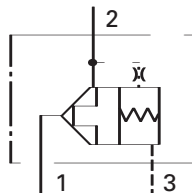

DPS2-**-S
Poppet, vent to open, normally closed

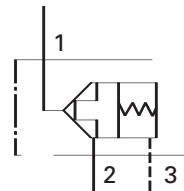

DPS2-**-T
Poppet, bi-directional pilot to close, 2:1 ratio, normally closed

Pressure compensators, restrictive

Functional Symbol

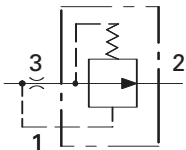

MODEL	CAVITY	FLOW RATING	TYPICAL PRESSURE	PAGE
Compensator spool element, restrictive type		L/min (USgpm)	bar (psi)	
PCS3-10	C-10-3	38 (10)	210 (3000)	I-22
PCS3-12	C-12-3	58 (15)	210 (3000)	I-24
PCS3-16	C-16-3	114 (30)	210 (3000)	I-26
PCS3-20	C-20-3	189 (50)	210 (3000)	I-28

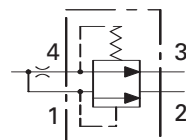

MODEL	CAVITY	FLOW RATING	TYPICAL PRESSURE	PAGE
Compensator spool element, priority type		L/min (USgpm)	bar (psi)	
PCS4-10	C-10-4	38 (10)	210 (3000)	I-30
PCS4-12	C-12-4	58 (15)	210 (3000)	I-32
PCS4-16	C-16-4	114 (30)	210 (3000)	I-34
PCS4-20	C-20-4	189 (50)	210 (3000)	I-36

Load Controls

Valve locator

Counterbalance valves

Functional Symbol

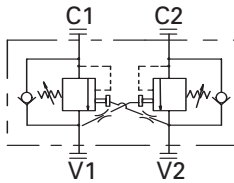
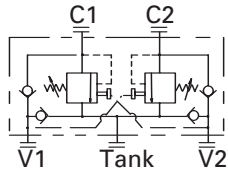
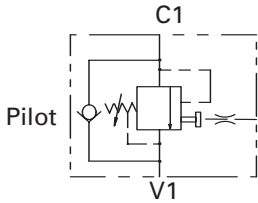
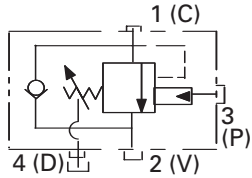
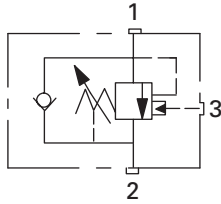

MODEL	CAVITY	FLOW RATING	TYPICAL PRESSURE	PAGE
Counterbalance		L/min (USgpm)	bar (psi)	
CBV1-10 (4:1 ratio)	C-10-3S	60 (15)	350 (5000)	H-6
CBV2-10 (10:1 ratio)				
CBV1-12 (4:1 ratio)	C-12-3S	114 (30)	350 (5000)	H-8
CBV2-12 (10:1 ratio)				

MODEL	CAVITY	FLOW RATING	TYPICAL PRESSURE	PAGE
Counterbalance with separate vent, 4:1 pilot ratio		L/min (USgpm)	bar (psi)	
VCB1-10	C-10-4 C-10-4U	60 (15)	350 (5000)	H-10
VCB1-12	C-12-4 C-12-4U	114 (30)	350 (5000)	H-12

MODEL	CAVITY	FLOW RATING	TYPICAL PRESSURE	PAGE
Inline housing type counterbalance,		L/min (USgpm)	bar (psi)	
MCV1-16 (11:1 ratio)	manifold	151 (40)	210 (3000)*	H-14
MCV1-20 (10:1 ratio)	manifold	190 (50)	210 (3000)*	H-16

MODEL	CAVITY	FLOW RATING	TYPICAL PRESSURE	PAGE
Dual housing type counterbalance, with anti-cavitation checks		L/min (USgpm)	bar (psi)	
MCV4-16 (11:1 ratio)	manifold	151 (40)	210 (3000)*	H-20

MODEL	CAVITY	FLOW RATING	TYPICAL PRESSURE	PAGE
Dual inline housing type counterbalance,		L/min (USgpm)	bar (psi)	
MCV2-20 (10:1 ratio)	manifold	190 (50)	210 (3000)*	H-18

* Indicates that these models are available for use above 210 bar (3000 psi). However, caution should be taken and a review of the application may be necessary prior to use. Contact your Eaton applications engineer.

Circuit Makers

Screw-in cartridge valve package solutions

Functional Symbol

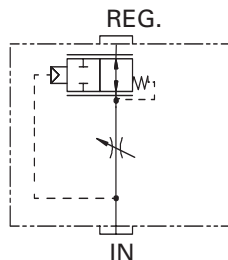
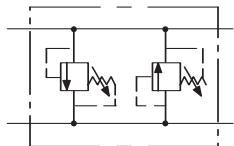

MODEL	FLOW RATING	TYPICAL PRESSURE	PAGE
Cross port relief valve		L/min (USgpm)	bar (psi)
CRV-10	76 (20)	17 - 210 (250 - 3000)	K-44
CRV-16	303 (80)	17 - 210 (250 - 3000)	K-46

MODEL	FLOW RATING	TYPICAL PRESSURE	PAGE
Full range adjustable pressure compensated flow control package		L/min (USgpm)	bar (psi)
FC-1	36 (9)	210 (3000)	K-4
FC-2	60 (15)	210 (3000)	K-6
FC-3	114 (30)	210 (3000)	K-8
FC-4	190 (50)	210 (3000)	K-10

Circuit Makers (cont.)

Valve locator

Screw-in cartridge
valve packages

Functional Symbol

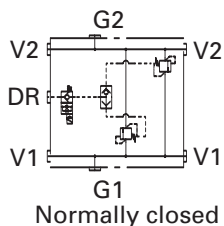
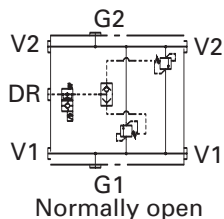
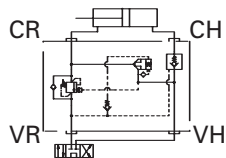
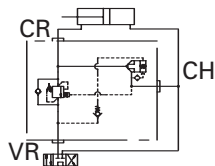
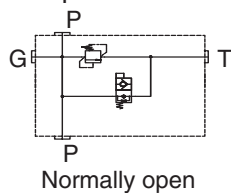
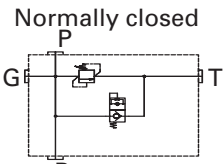
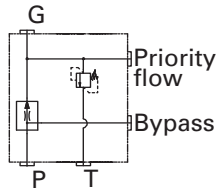
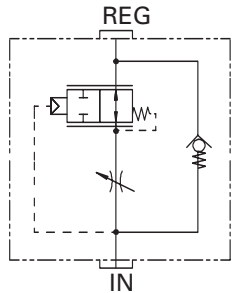

MODEL	FLOW RATING	TYPICAL PRESSURE	PAGE
Full range adjustable pressure compensated flow control package with reverse free flow			
	L/min (USgpm)	bar (psi)	
FRC-1	36 (9)	210 (3000)	K-12
FRC-2	60 (15)	210 (3000)	K-14
FRC-3	114 (30)	210 (3000)	K-16
FRC-4	190 (50)	210 (3000)	K-18

MODEL	FLOW RATING	TYPICAL PRESSURE	PAGE
Fixed priority flow control manifold			
	L/min (USgpm)	bar (psi)	
PFRR-8	15 (4)	7 - 210 (100 - 3000)	K-28
PFRR-10	60 (15)	7 - 210 (100 - 3000)	K-30
PFRR-16	152 (40)	7 - 210 (100 - 3000)	K-32

MODEL	FLOW RATING	TYPICAL PRESSURE	PAGE
Pump control manifold (normally closed)			
	L/min (USgpm)	bar (psi)	
PCC1-12	114 (30)	5 - 210 (75 - 3000)	K-20
PCC1-16	228 (60)	10 - 210 (150 - 3000)	K-22

MODEL	FLOW RATING	TYPICAL PRESSURE	PAGE
Pump control manifold (normally open)			
	L/min (USgpm)	bar (psi)	
PCC2-12	114 (30)	5 - 210 (75 - 3000)	K-24
PCC2-16	228 (60)	10 - 210 (150 - 3000)	K-26

MODEL	FLOW RATING	TYPICAL PRESSURE	PAGE
Pressure sensitive regenerative			
	L/min (USgpm)	bar (psi)	
RGV-10	60 (15)	210 (3000)	K-48
RGV-12	114 (30)	210 (3000)	K-50

MODEL	FLOW RATING	TYPICAL PRESSURE	PAGE
Pressure sensitive regenerative w/load locking			
	L/min (USgpm)	bar (psi)	
RLV-10	60 (15)	210 (3000)	K-52
RLV-12	114 (30)	210 (3000)	K-54

MODEL	FLOW RATING	TYPICAL PRESSURE	PAGE
Cross port relief w/shuttle and solenoid vent			
	L/min (USgpm)	bar (psi)	
SCR-1	114 (30)	210 (3000)	K-56

Circuit Makers (cont.)

Valve locator

Screw-in cartridge
valve packages

MODEL	FLOW RATING	TYPICAL PRESSURE	TYPICAL VENTED ΔP	PAGE
Solenoid actuated relief valve	L/min (USgpm)	bar (psi)	bar (psi)	
SRV-8	23 (6)	210 (3000)	4 (60)	K-34
SRV-10	60 (15)	210 (3000)	7 (100)	K-36
SRV-12	114 (30)	210 (3000)	10 (150)	K-38
SRV-16	225 (60)	210 (3000)	8 (120)	K-40
SRV-20	300 (80)	210 (3000)	9 (135)	K-42

Functional Symbol

